

SRC-TS SERİSİ TEKNİK ÖZELLİKLER

KİLİTLEME ÜNİTESİ

		SRC 160-TS	SRC 230-TS	SRC 260-TS	SRC 290-TS
Kilitleme Kapama Kuvveti	kN	1600	2300	2600	2900
Mengene Mesafesi	mm	445	490	540	600
Kolonlar Arası Mesafe (Y x D)	mm	470 x 470	535 x 535	580 x 580	640 x 640
Plaka Boyutları (Y x D)	mm	691 x 691	800 x 800	860 x 860	910 x 910
Maksimum Kalıp Kalınlığı	mm	520	560	610	650
Minimum Kalıp Kalınlığı	mm	180	200	220	220
İtici Mesafesi	mm	140	140	150	150
İtici Kuvveti	kN	39.6	62	62	70

ENJEKSİYON ÜNİTESİ

		550			830			1000			1340		
		A	B	C	A	B	C	A	B	C	A	B	C
Vida Çapı	mm	40	45	48	45	50	55	50	55	60	55	60	65
Vida LD Oranı	L/D	22.5	20	18.8	23.3	21	19.1	22.5	20.5	18.8	21.8	20	18.5
Enjeksiyon Hacmi	cm ³	270	342	389	398	491	594	491	594	707	665	791	929
Enjeksiyon Ağırlığı (PS)	g	243	308	350	362	447	540	442	534	636	605	720	845
Enjeksiyon Ağırlığı (PS)	oz	8.6	10.9	12.4	12.8	15.8	19.0	15.6	18.8	22.4	21.4	25.4	29.8
Enjeksiyon Basıncı	bar	2150	1690	1490	2100	1700	1410	2050	1690	1420	2020	1700	1450
Enjeksiyon Hızı	mm/s	109	109	109	100	100	100	113	113	113	110	110	110
Enjeksiyon Kapasitesi (PS)	g/s	125	158	179	139	172	208	163	197	234	238	283	332
Mal Alma Kapasitesi (PS)	g/s	22.8	31.7	35.7	18	23.2	29.3	31.5	41.2	49	37	43	48
Enjeksiyon Mesafesi	mm	215			250			250			280		
Vida Hızı	rpm	0 - 200			0 - 200			0 - 180			0 - 205		

GENEL BİLGİLER

Maksimum Çalışma Basıncı	bar	160			160			160			160		
Servo Motor Gücü	kW	18.7			23			29			30		
Isıtma Gücü	kW	14			20.9			17.3			24		
Makine Ölçüleri (U x G x Y)	m	4.9 x 1.27 x 2.16			5.5 x 1.36 x 2.40			5.93 x 1.4 x 2.32			6.60 x 1.85 x 2.30		
Hidrolik Yağ Kapasitesi	L	300			300			405			400		
Makine Ağırlığı	t	4.94			7.3			7.51			11		

PLAKA BOYUTLARI

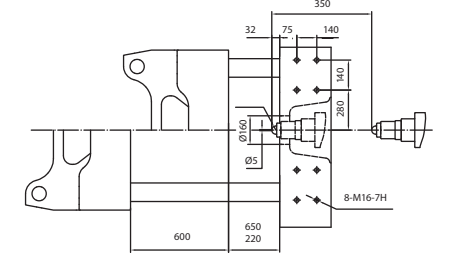
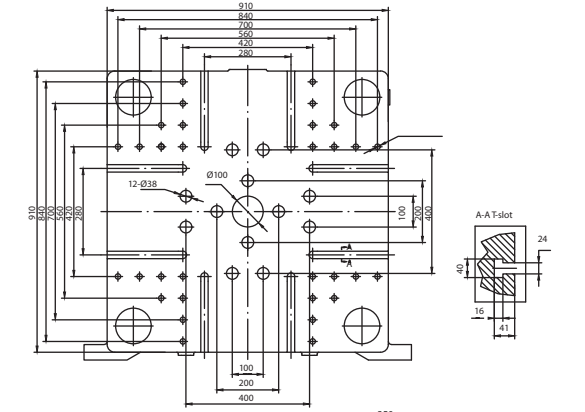
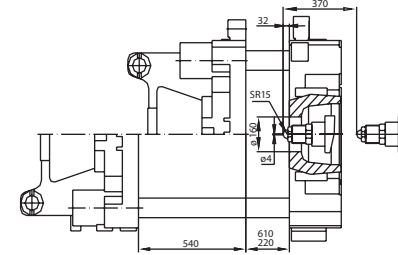
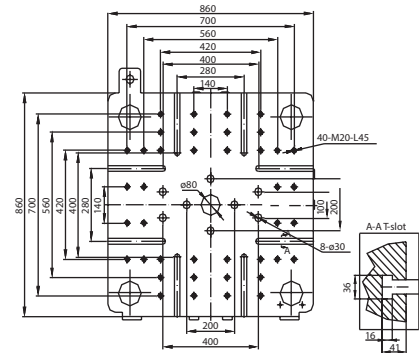
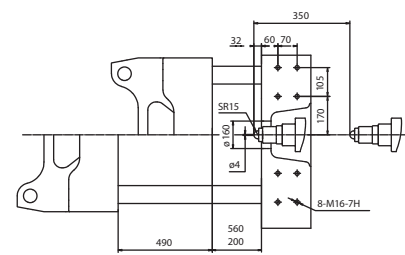
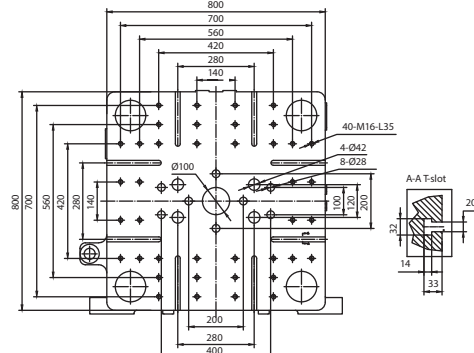
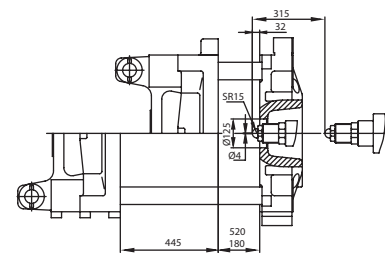
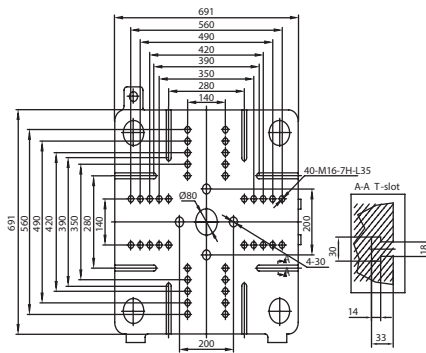

MAKİNE BOYUTLARI

